

**INNOVATIONS IN SMALL EXTRUDERS
THAT
PROMOTE FEEDING AND PRESSURE STABILITY**

BY

KEITH LUKER

RANDCASTLE EXTRUSION SYSTEMS, INC.

74 SAND PARK ROAD
CEDAR GROVE, NJ 07009

Abstract: This paper discusses innovations in small extruders that lead to enhanced pressure stability. Historical context is given to the problem of feeding and strength in small extruders. This is followed by the presentation of data on novel smooth bore feed sections that have been found to alter the feeding characteristics of small extruders (1 inch and under). Then, data is presented on two patent pending Surge Suppression devices and an associated control scheme. The data shows the effects of the Surge Suppressor on both short and long term surging.

History: Most feed stocks are pelletized. Most commonly, they take the form of spheroids, and cylinders though they may be cubes or hexagonal. Typical pellets are nominally 0.13 inch (1/8 inch) but many pellets have a major dimension about 50% larger or about 0.19 inch (3/16 inch). The majority of extruded plastics are processed through large extruders. However, in the medical industry the cross sections of products such as catheters are so small that extruders must be correspondingly small. Large extruders that run very slowly suffer from long residence time and subsequent polymer degradation.

Small extruders, on the other hand, can process plastics at conventional screw speeds thus avoiding degradation. However, as extruder screws get smaller, conventional pellets become relatively larger. Over time, several problems were identified:

1) Packing Density: Pellets must fit in the feed channel of the extruder screw. If a one inch screw is built with a feed channel depth of about 0.19, most pellets will fit into the channel and feed. Pellets can then pack side by side in a single layer. Contrast this with the packing in larger extruders where pellets pack three dimensionally somewhat like stacked cannon balls. This higher density packing in larger extruders is advantageous because the feed channel will more likely be regularly filled. Uniform filling in the feed channel promotes uniform pressures. Without this uniform packing, small extruders tend to have an erratic feed and consequently less stable melt pressure.

2) Weak Screws: The obvious solution to the problem of a small channel depth is to make a larger channel depth. One inch screws can be made with channel depths up to about 0.24 inches in feed channel depth. However, such larger channel depths weaken the screw very substantially. Such screws are easily broken in the solids conveying zone because the load is bigger than the screw root can withstand. One large extruder manufacturer, while using a 3 HP drive capable of 15 amps, has a limiting amperage of only 9.5 amps maximum to prevent the screw from breaking.

A second problem has also been observed. Small dies, rather common with small extruders, often generate substantial pressures of between 3,000 and 7,500 psi. This pressure pushes on the tip of the screw. One inch screws having a feed channel depth of about 0.24 inches have been observed to “compress” from this pressure losing up to 0.7 inches in length. The feed root diameter becomes larger to compensate for the change in pitch. Some polymers are corrosive at process temperature such as most members of the fluorocarbon family. Nickel based alloys tend to be soft and are particularly prone to this compression problem.

Both problems are worse for extruders smaller than one inch. Three-quarter inch extruders, for example, could not practically be built with channel depths larger than 0.190 inches. At 0.19 inches, these screws had significant feeding and screw breakage problems.

Screws smaller than three-quarters of an inch were generally thought impractical because they did not survive when tried.

3) Feed Throat Design: Conventional extruders have a hole in the barrel where the pellets fall by means of gravity into the screw. This hole is surrounded by a water cooled section jacket. This prevents polymer from melting prematurely and causing a lack of feed. This section of the barrel is called the "feed throat" or "barrel feed section."

Large extruders pass conventional pellets readily through the feed throat to the screw channel. While several feed throat designs are possible, larger extruders are often fed from the top through a hole smaller than the screw diameter. The literature describes different types of smooth bore feed sections (Ref. 1). Among these is a top dead center feed; a tangential design where the feed is offset from the screw diameter but vertical; and a tangential design where one side of the feed is angled thus forming a wedge with the feed. The tangential designs are recommended for melt fed rather than solid feed stocks. Another type of smooth bore design is known from the rubber industry as a roll feeder and is designed to feed in strips of material rather than free flowing feed stocks.

Several texts sketch the dimensions of the feed throat (Ref. 2, 3,4). From the scale of these drawings, the barrel holes are somewhat smaller than the screw barrel diameter across the screw and about the same length as the barrel diameter along the screw axis.

Manufactures of small extruders have long known that the size of the feed throat matters greatly. Typical pellets will readily "arch" (that is, form a mechanical bridge) over a diminutive three-quarter inch opening in a one inch extruder. This "arching" stops material from reaching the screw. A similar problem exists in reclaim extruders. Reference (6) shows both a standard construction and the construction required to solve feeding problems associated with reclaim.

The feed sections have been "enlarged" by some manufacturers of small extruders in an attempt to get the material to the screw and avoid arching. One manufacturer, for its 3/4 and 1 inch extruders, enlarges the feed throat opening in an unusual way. Above the screw centerline, the opening is 1.5 times the diameter of the screw. The opening axial dimension is made about two times the screw diameter. To a significant degree, this solves the arching problem.

While arching is reduced, a consequence of the increased feed opening is a reduction in solids conveying. This is because the large hole lessens the barrel contact with the pellets which in turn *reduces solids' transportation*. Another consequence is that the larger feed opening, at least from one manufacturer, comes at the expense of uniform water cooling and at the expense of the feed section's L/D ratio. This creates feed throats with temperatures that may be about 60F at the six o'clock position and 250F at 12 o'clock because of a lack of water cooling in this area. Such designs lack reliable solids conveying because radial temperature regulation is so poor.

The root causes of these problems were pretty much ignored by small extruder manufacturers and treated as "insurmountable." Instead of addressing these problems directly, they offered three "solutions" to these problems:

1) Grooved Barrels (also called "Grooved Feed Throats and Grooved Feed Sections"): To solve the problems of inferior feeding, grooves were added to the feed sections in the 1980's. Grooved feed throats have one or more grooves in their bore. Usually, these grooves are parallel to the axis of the screw and are rectangular but they may be hemispherical, trapezoidal, and helical (Ref.: 7, 8, 9). The grooves effectively trap the pelletized feed stocks in the grooves against the screw helix increasing the coefficient of friction by about two or three times. Consequently, transportation increases substantially and the screw design is altered accordingly. Typical compression ratios are decreased from about 3:1 to about 1:1.

Several variables are known to contribute to feeding in grooved barrel feed sections. The number of grooves, the length of the grooves, and the shape of the grooves can all be tailored to specific materials (Ref. 7,8). Thus, the machine designer and processor have a range of choices in grooved barrels to meet his requirements.

Several manufactures offer both smooth and grooved bore barrels. Interestingly, smooth bore extruders have remained more popular in the United States than grooved bore barrels even though grooved bore barrels offer significant advantages in many respects. Possibly, this is because smooth bore feed sections are more flexible than grooved bore barrels. That is, grooved bore barrels are designed for specific materials. This may not allow for a very wide range of polymer processing (unless auxiliary feeders are used).

For both smooth bore designs and grooved bore designs, typical horizontal extruders place the feed section of the barrel between the main portion of the barrel and the thrust section. This natural placement makes it difficult to change from one type of feed section to another. To make a change on a one inch extruder, the screw must be removed. This might take 15 minutes to 1 hour depending on the material. The barrel cover must be removed and the screws that hold the barrel must be removed. There are two other considerations in that the barrel may be hot (from the heat required to remove the screw) and the barrel wires might have to be disconnected. This may also be time consuming and may involve additional people in the process. The screws that hold the feed section to the barrel are then removed. The feed section is replaced and the extruder is reassembled. So, the replacement process is somewhat time consuming even on a small typical extruder.

The screw used with a grooved throat must still allow the pellets to fit into the screw channel. So, the one inch screw is usually equipped with a feed channel depth of at least 0.180. Since the "metering depth" is the same as this feed depth, the output of the screw is about two to three times higher for the same screw speed. It should be noted that high output is counterproductive in the manufacture of small cross sectional products such as catheters. So, while grooves increase the solids conveying and yield substantially more uniform pressures, they do so at a "cost" of higher output.

2) Gear Pumps: Gear pumps are well known to yield very stable pressures and under some circumstances seem the best way to achieve uniform outputs. They do have well know disadvantages including expense, complexity of operation, are not necessarily perfect "In/Out" pumps (so degradation is possible), and are tedious to dismantle and clean.

In any event, even when necessary and appropriate, gear pumps should not be used with poorly feeding extruders. This is because a gear pump only makes the output more uniform volumetrically. It does not improve the quality of a poorly melted or mixed extrudate that results from erratic solids transportation (feeding).

3) Dual Diameter Screws: One company has recently displayed a dual diameter screw design rather similar to the "Pirelli Rubber Extruder" (Ref. 10). The soft rubber deforms in the conical feed throat where there is a large clearance between the screw and wall. This type of extruder has also found used in larger extruders where it is used to densify scrap such as the fluff made from ground bags (Ref. 11). This type of feed stock is also soft in the sense that there is so much air in the feed stock (unlike dense hard pellets) that the feed stock is readily compressible.

The extruder displayed had a 3/4 inch feed section followed by a 1/2 inch screw. Neglecting the earlier comments about the strength of a 3/4 inch screw, uniform cooling requirements, feeding, and barrel feed geometry, it is worth noting the following:

- a) **Changing Screws:** The barrel must be removed in order to remove the screw for cleaning or changing the screw.
- b) **Expensive Screws:** It is very likely that dual diameter screws and barrels will be more expensive than screw of a single diameter when replaced.
- c) **Screw Design:** It must be remembered that any screw is a balancing act. The solids conveying zone must transport the correct amount of material to fill the metering section of the screw. The 3/4 inch screw should have a feed channel depth large enough for typical pellets. It is likely that the second screw diameter will have a rather large thread depth to accommodate the relatively large volume of material from the larger 3/4 inch screw. It may be difficult to balance the feed amount with the metering zone.
- d) **Wear:** The exhibited extruder had a relatively short transition between the first and second screw. One might expect this sudden transition to be a significant wearing zone for the barrel and screw. Conventional hard pellets will not deform as easily in the diminishing space of the tapered barrel as soft rubber and soft fluff- the traditional uses of tapered barrels.

Wear, either from corrosive or abrasive causes, is a common problem in extruders. It is often solved by the use of bimetallic liners composed of either abrasion or corrosion resistant materials. The author is not aware of conical bimetallic liners in this size range.

INNOVATIONS

I) INTRODUCTION: This paper describes three innovations that yield more stable pressure and consequently more uniform products. The first innovation was the discharge driven extruder that Randcastle commercialized in 1988. In turn, this lead to two more innovations that can give more stable pressures. We will describe the behavior of different smooth bore feed throats and a patent pending Surge Suppression Device.

II) DISCHARGE DRIVEN EXTRUDER DESIGN: This first innovation was the introduction of a vertical extruder driven from the discharge end of the extruder. This design solves some of the historical problems that were generally thought insurmountable. As has been discussed,

screw strength was a limiting factor that had stopped machine builders from making extruders smaller than about three-quarters of an inch.

In a typical extruder, the entire load of the extruder is transmitted through the root diameter of the screw under the hopper. This is usually where the root diameter of the screw is smallest and consequently weakest.

The formulae for allowable stress for main power-transmitting shafts (using 4,000 pounds per square inch) can be used as a simple approximation of the screw root diameter:

$$P = \frac{D^3 N}{80}$$

where: P= Power transmitted in horsepower

D= Diameter of the shaft in inches

N= Angular velocity of shaft in revolutions per minute

Using a three-quarter inch diameter screw having a channel depth of 0.180 inches as an example, the root diameter of the solid conveying region would be about 0.390 inches. At 80 revolutions per minute, $0.390 \times 0.030 \times 0.390 = 0.059$.

In a discharge driven design, the entire load of the extruder is transmitted through the metering section root diameter. Typically, this root diameter is significantly bigger. Using a typical 3:1 apparent compression ratio for the meter channel depth and the same feed channel depth of 0.180 inches, the meter channel depth would be 0.060 inches. The root diameter for the meter would then be about 0.63 inches. At 80 revolutions per minute, 0.63^3 equals 0.25.

Dividing, $0.25/0.059 = 4.23$. So, the same screw driven from the discharge end of the screw is about four times stronger than a conventional screw. This is not completely correct of course since some of the load is transmitted through the tapering root diameter of the melting zone. There is every reason to believe, however, that discharge driven screws are substantially stronger than conventionally driven screws. In practice, discharge driven extruders are now built as small as 0.25 inch in screw diameter and 0.500 inch diameter for conventional 0.13 inch pelletized feed stocks.

III) FEED THROATS FOR DISCHARGE DRIVEN DESIGNS:

A) Arching Resolved: As discussed earlier, one of the problems with conventional small extruders was getting the pellets to the screw. Arching (mechanical bridging of the pellets over the feed throat opening) was a significant problem. Because the pellets did not arrive regularly at the screw channel inconsistent feeding resulted. Once the extruder is discharge driven, the problem of getting the feed stock to the screw is resolved merely by extending the screw into the feed throat. See Drawing 1.

In addition, because the screw is rotating within the feed section, the end of the screw can be modified to stir materials with the hopper. This is useful with materials that are not free

flowing such as sticky pellets that have a tendency to "funnel" or "rat-hole" well above the feed throat. See Drawing 1.

B) L/D Properly Cooled: The feed throat is made with a chambered cooling system that is three L/D's long. The chambered cooling forces material to flow from one chamber to the next to ensure uniform cooling. Because the feed section has a working cooled length of 3 L/D's, feed throat friction reliably transports material in this portion of the solids conveying zone.

C) Innovative Smooth Bore Feed Throats: Randcastle has devised a means to change how much material is transported by means of different types of smooth bore feed throats. This changes the packing density making the feeding behavior more like larger extruders. Earlier in this paper, it was noted that the typical choice offered the purchaser was either a smooth bore feed throat or a grooved bore feed throat. This choice alters the feeding behavior radically. As a consequence, the screw's apparent compression ratio must also be changed radically. Smooth bore apparent compression ratios are typically between 2:1 and 4:1 for smooth bore feed throats and about 1:1 for grooved bore feed throats. The amount of feed is therefore balanced with the metering section of the screw.

However, Randcastle has discovered that this general principle may also be applied to smooth throat feed sections as well. That is, Randcastle has discovered that different smooth bore feed throats affect transportation (feeding). Unlike smooth versus grooved feed sections, feeding is altered in smaller amounts.

D) SET-UP FOR TESTING: Randcastle offers four types of smooth bore feed sections. One type is the roller feed section designed for strip feed and will not be discussed in the paper. The other three types were installed on a Randcastle 5/8 inch extruder so that different materials could be processed and the effects observed. Specifically, we were interested in output and pressure stability of these feed sections. We wanted to know if we could alter the feeding characteristics without changing the screw. This would allow the option of changing either the screw for more uniform flow or changing the feed section.

Unlike the conventional extruder, Randcastle's feed sections can be changed without removing the screw. Because the feed section is held in place with only four screws, the feed sections can be changed in about a minute. This means that production downtime can be minimized and catheter production increased.

The experiments were carried out using a single general purpose Randcastle screw design having a 3:1 compression ratio with 8 L/D's of meter, 8 L/D's of transition, and 11 L/D's of feed. The screw had a minimal impact Surge Suppressor installed.

The specific smooth bore barrel feed section designs are, of course, proprietary. They will be referred to here as "Standard, Classic, and Aggressive." This is useful and necessary from an identification point of view. However, these are just names and the reader should not read too much into the names themselves.

E) RESULTS OF FEED THROAT TESTING:

1) **HDPE:** The first material that was processed was HDPE from Federal Plastics #F15896. This was an underwater cut pellet. Barrel conditions for all trials were zone one 360F, Zone two 370F, Zone three 380 F, and the die at 380F. The extruder used was a standard Randcastle Microtruder with a working L/D of 24/1. The graphical results are:

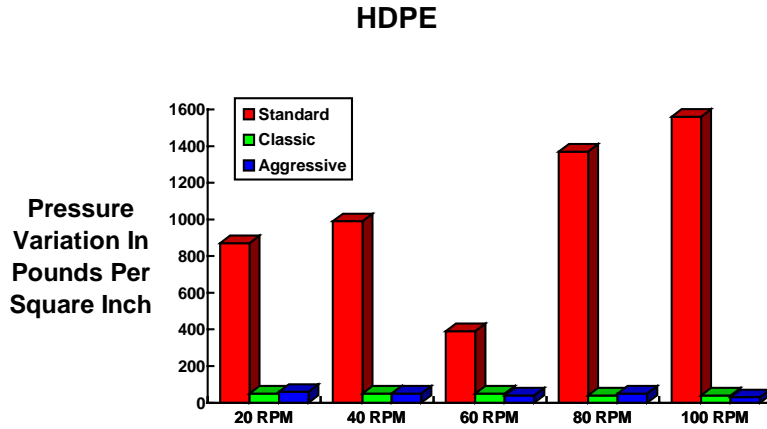

The conclusion is that the "Standard" feed section was not stable but that both the "Classic" and "Aggressive" smooth bore feed sections produced very good average fluctuations during the test. Averaged pressure fluctuations for the "Classic" feed section were plus or minus 23 psi and for the "Aggressive" feed section plus or minus 22 pounds. Average output for the "Classic" barrel feed section was 0.30 grams per revolution while the "Aggressive" feed section yielded 0.32 grams per revolution.

The output for the HDPE was:

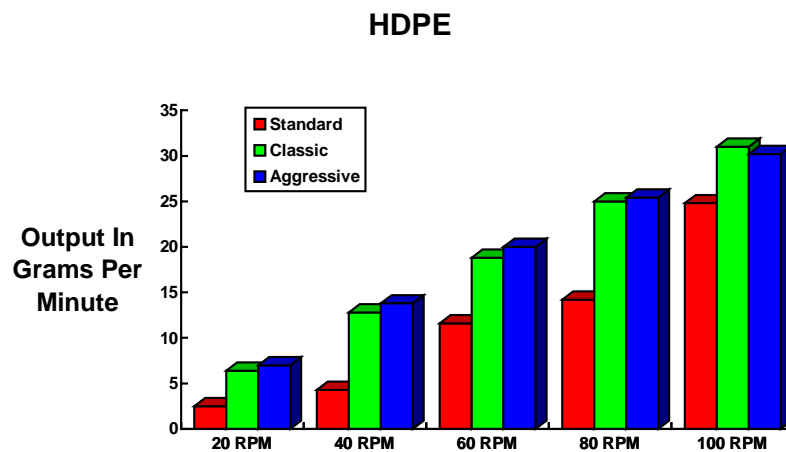

The output from both the "Classic" and "Aggressive" feed throats are much higher than the "Standard" feed throat and both produced stable pressures. This infers that the "Standard" feed throat supplied too little material to the metering section and it was consequently starved and surged.

2) **LLDPE**: The next material that was tested was LLDPE at barrel zone temperatures of 385, 390, 400, and 400 F from the feed to the die. The pressure variation follows:

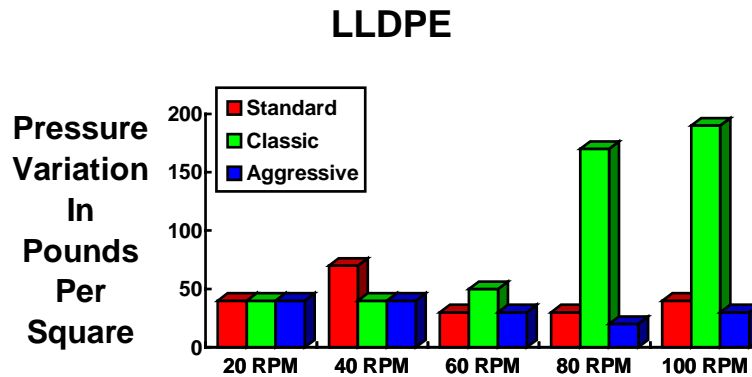

The output graph for the LLDPE follows:

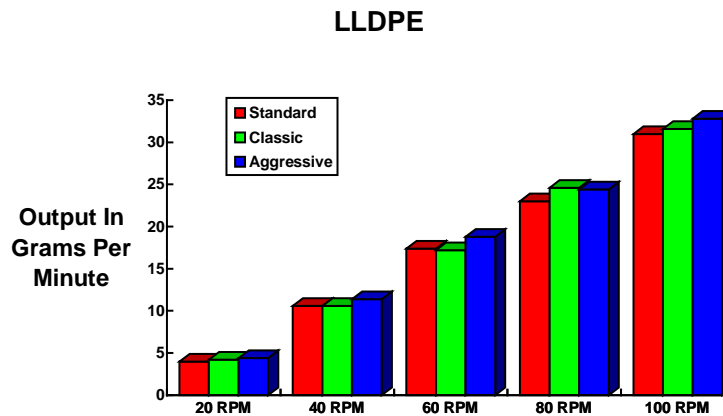

As in the case of the HDPE, the output is consistently higher when changing from the "Standard" to the "Classic" to the "Aggressive" feed throats. Unlike the HDPE trial, the output fluctuation for the "Classic" feed throat is probably not because the metering section is starved. After all, the average output values are lower for the "Standard" feed throat (compared to the "Classic" feed throat) but higher for the "Aggressive" feed throat. It seems more likely that some other aspect of the process is causing the instability.

We then modified the LLDPE but modified to make it excessively slippery. To this, we sprayed the feed stock with an aerosol mixture of "Fluoroglide" and "WD-40" and mixed the pellets to distribute the spray. Processing conditions were kept the same as during the virgin tests above. Under these circumstances, the "Standard" feed throat and "Classic" feed throat produced wildly unstable pressures while the "Aggressive" feed throat did not. The following graph shows the approximate fluctuations at 100 RPM for all three feed throats:

LLDPE WITH FLUOROGLIDE AND WD-40

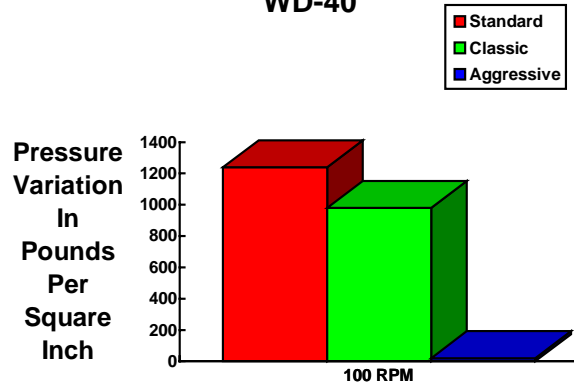

The pressure variation for all speeds on the Aggressive feed section for the LLDPE was:

LLDPE WITH FLUROGLIDE AND WD-40

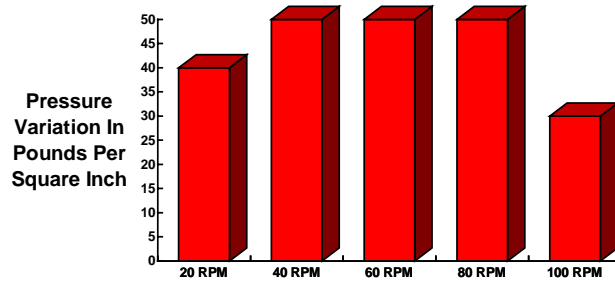

And the output for this trial was:

LLDPE WITH FLUROGLIDE AND WD-40

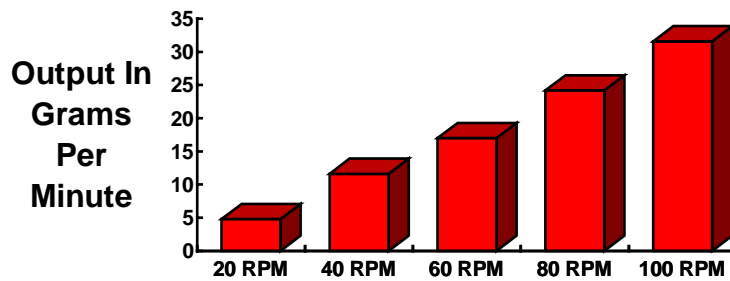

This is a rather interesting result. If you compare the output using the virgin LLDPE and the LLDPE with the Fluoroglidle and WD-40 using the "Aggressive" feed throat, they are very similar. The pressure was terribly unstable with the "Standard" and "Classic" feed throat. The conclusion is that the "Aggressive" feed throat is less sensitive to changes in the feed stock's coefficient of friction.

3) **LDPE:** The next material tested was a Federal LDPE #Nat:F13600 at temperatures starting at the hopper and moving progressively down the die from 300, 325, 350 and 350F. The output pressures were:

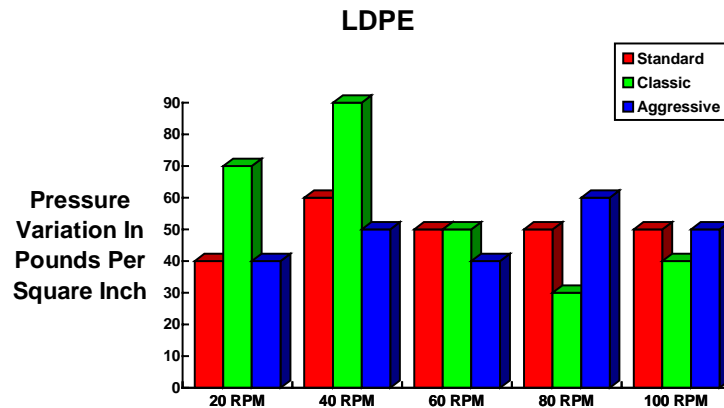

The pressure for the LDPE tested was:

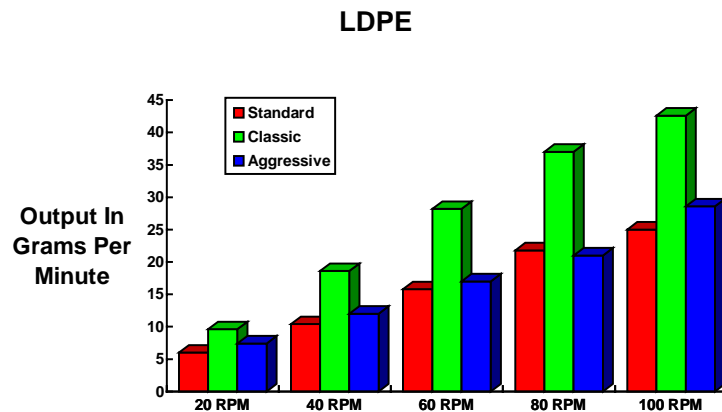

Apparently, in this case, the "Classic" feed section fed much better than either of the other two feed sections. Apparently, it fed too well and as a result overwhelmed (at this set of process conditions) the screw's metering section making the pressure unstable. Additional evidence may be seen in the motor amps shown below:

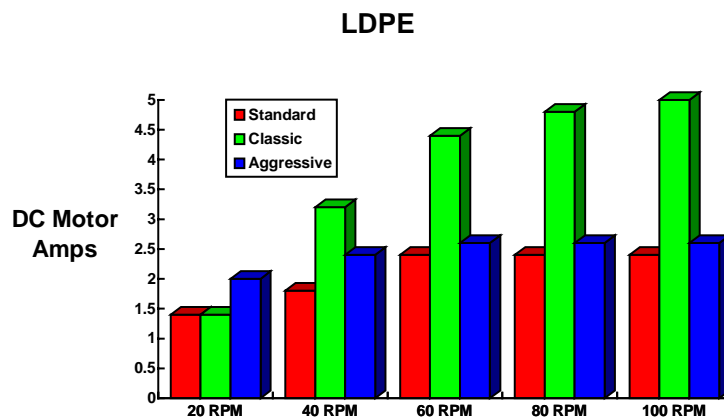

4) **FLEXIBLE PVC:** The last material tested was flexible PVC from Federal Plastics. It was a clear flexible underwater cut feed stock #F15763 and was processed with profile of 350 at the hopper, 345 at zone 2, 340 in zone 3 and 335 at the die. Pressure stability was:

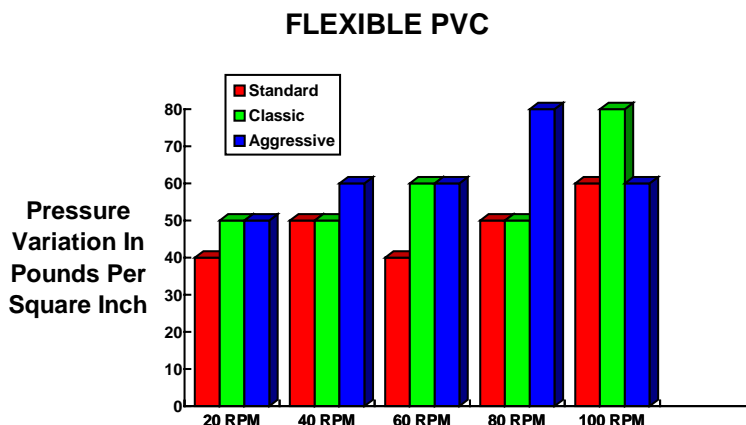

In this case, the "Standard" feed section seems to have performed most reliably. The output was:

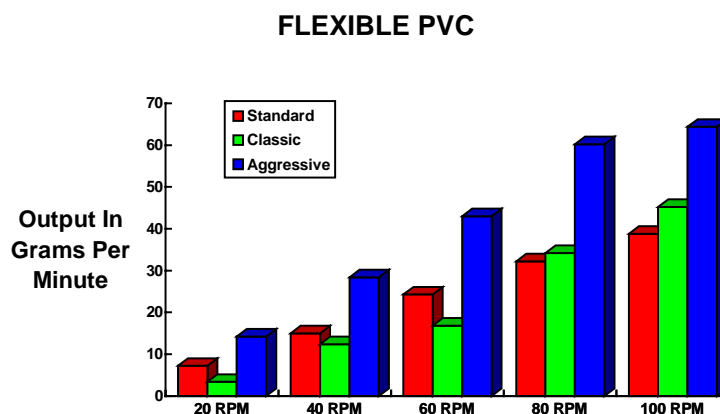

All these outputs seem strikingly high compared to the previous trials even given flexible PVC's high specific gravity.

5) **URETHANE:** Trials were also made on a series of urethanes. Specifically, a 55D and 75D strand cut Tecothane and a 55D and 75D Pellathane. This allows a comparison of members of the same family of polymers and a quick look at the effect of the pellet hardness or durometer on different feed sections. Sample sizes were severely limited so that data could not be duplicated during these trials. Also, long term pressure stability is not likely to be as good as is shown:

TECOTHANE 55 D (Strand Cut Feedstock)

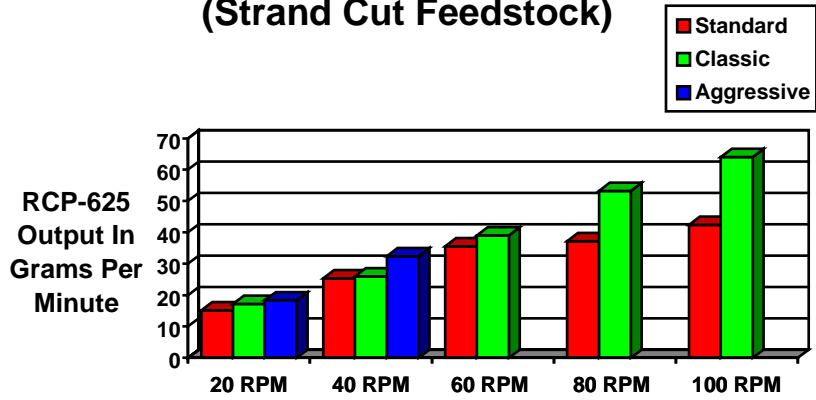

TECOTHANE 55 D (Strand Cut Feedstock)

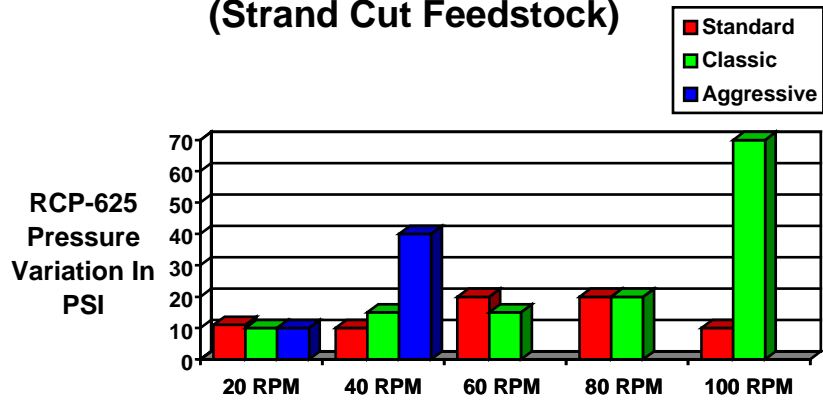

The Tecoflex 55D can now be compared to the 75D:

TECOTHANE 75 D (Strand Cut Feedstock)

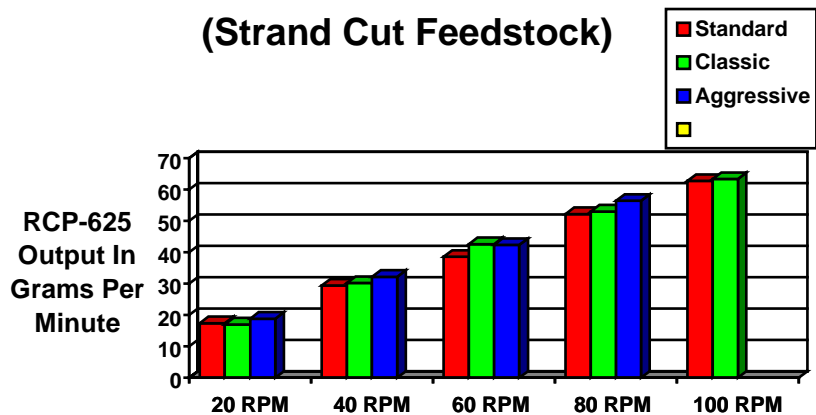

TECOTHANE 75 D (Strand Cut Feedstock)

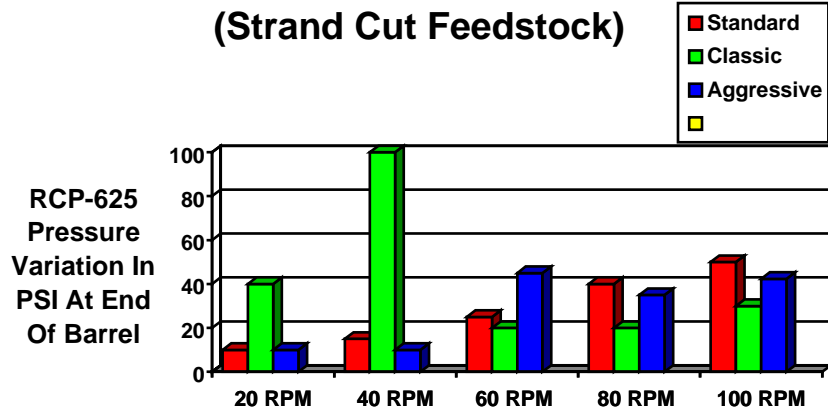

The Tecothane results of output show a consistent overall trend. The pressure stability does not follow the output trend. As in other trials, the best pressure stability seems to vary with screw speed and the type of feed section.

The Pellathane results were as follows:

PELLATHANE 55 D (Hex Diced Feedstock)

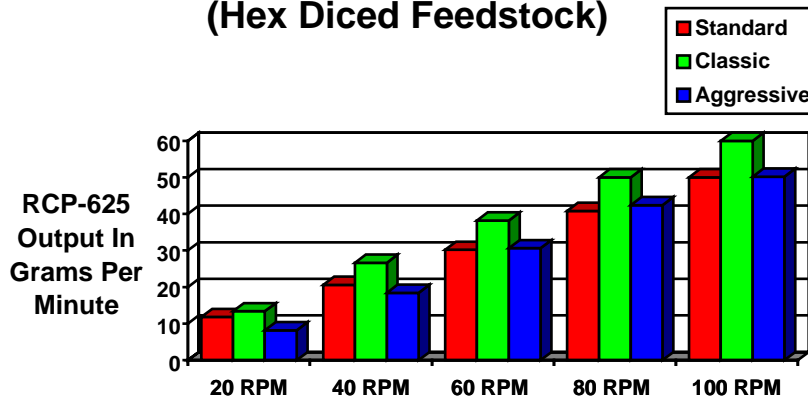

PELLATHANE 55 D (Hex Diced Feedstock)

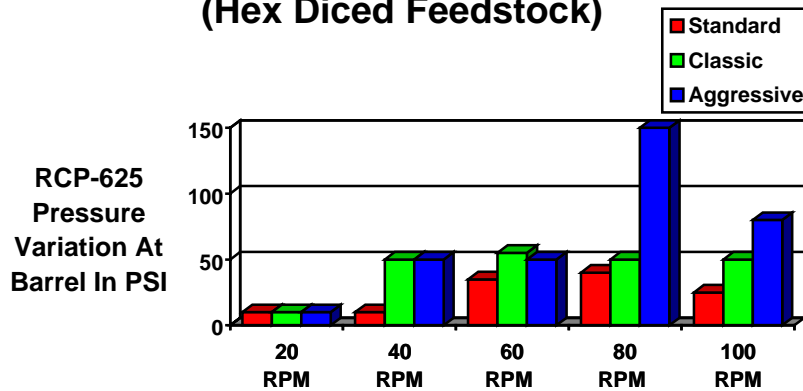

It's certainly interesting that the highest outputs are consistently given by the "Classic" feed section for the Pellethane 55D. This was not the case for either of the Tecothanes where the "Aggressive" feed section, where used, had the highest output.

These results can then be compared to the 75D Pellethane:

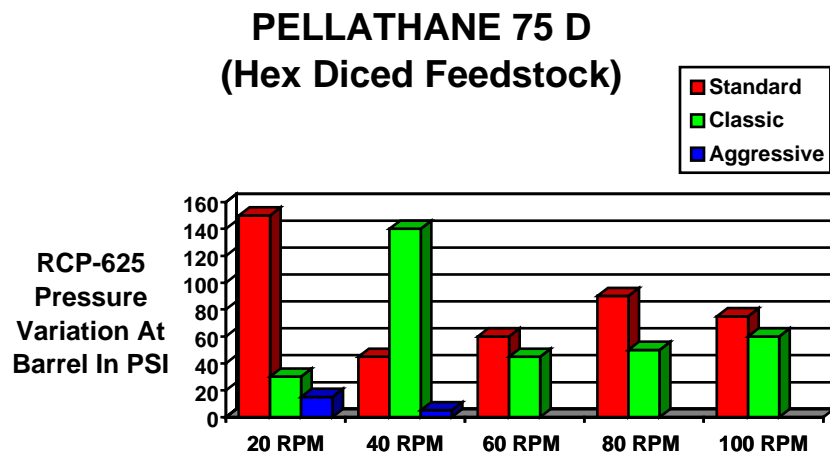
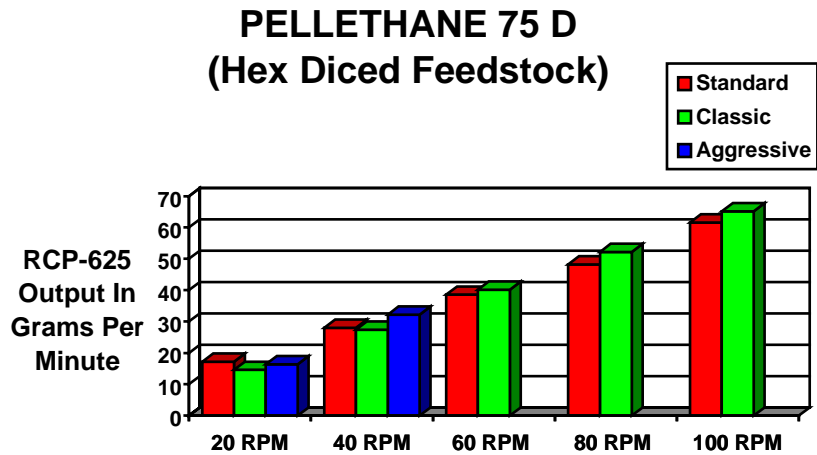

It is again interesting. Although the "Aggressive" feed section could only be used at the lowest speeds because of amperage limitations at the processing conditions specified, the pressure stability was significantly better than the others. It is also interesting that the "Standard" feed section was best for the 55D Pellethane but in all cases it the worst for the 75D.

F) CONCLUSIONS REGARDING THESE NOVEL FEED THROATS:

1) Effect Of Process Conditions: In these experiments, one particular set of conditions was selected for each material and for all the feed throats. This makes for good science but not necessarily for the most stable pressures. If process conditions were changed, the results might change. We made no attempt to find ideal (as measured by pressure) temperatures and, consequently, we doubt that we found them. We think that the general trends (like the "Standard" feed section forwarding the least material) will not be greatly influenced by typical processing changes.

2) Effect Of Screw Design: These experiments were all done with one screw. It is a rather ordinary design (3:1 apparent compression ratio where 8 L/D's were meter, 8 L/D's were compression, and 8 L/D's were feed). We expect different results with a different screw design. We base this expectation on our lab experience with a very similar screw different only in its 4:1 apparent compression ratio. If I summarized this study on its own, I might say that the "Aggressive" feed throat was about as useful as the standard feed section. This has not been our experience with the 4:1 screw. The "Standard" feed throat is much more useful and the "Aggressive" the least. This does not surprise us. There is only so much room in the metering section of a screw. If you convey more material forward from the hopper because the screw's apparent compression ratio is higher, there is less room for material conveyed by an "Aggressive" feed throat.

3) Synergistic Effect: These results suggest something rather unexpected. Originally, we thought that we could use simply change these feed throats to convey more or less material per revolution as an aide to proper filling of the screw. We thought that this would simply be easier to work with because you can change feed throats in about one minute without removing the screw or die. We knew that feed throats cost less than screws so we figured this was good. But, we also thought that changing screws to another design would work just as well. Now, we are not so sure. We think that, at this size extruder, the specific pellet shape, hardness, and friction interact with the specific feed throat. This interaction seems to cause a positive, negative, or neutral reaction in terms of pressure stability. Sometimes (looking at the "Classic" feed throat for LDPE) it seems to do both depending on screw speed. The question is, do these feed throat designs convey advantages beyond what a screw change might? We think so.

It is clear, for example, that the "Classic" feed section had a significantly higher output at all speeds for the LDPE trials. It is equally clear that the "Aggressive" feed throats had significantly higher output for the flexible PVC trials. Since the geometry of the feed throats did not change and since the pellets did not change, we must suppose that something else changes transportation. Similar logic might be applied to the trials LLDPE and modified LLDPE.

We think that pellet shape and hardness (interacting with the different feed throat geometry) are the most likely causes of these results. Pellet shape is probably important because of packing density. That is, spheres pack differently than cylinders or diced pellets. We think that these different feed throat geometry arrange or organize the pellets in different ways. Sometimes the reorganization yields more consistent packing and therefore feeding and more stable pressures. Sometimes not.

We think that pellet hardness is probably involved too because hardness is related to shape change. The data on the Tecothane 55D and 75D may support this conclusion. Both samples were the same form (strand cut pellets) and the processing temperatures were very similar (there was a 5F temperature difference in the third barrel zone). The Pellathane 55D and 75D experiments support a similar conclusion for the same reasons.

IV: SURGE SUPPRESSER DEVICE: Until recently, the only solution to improving pressure stability in an existing screw design was by means of fine tuning a particular screw design or by adding a gear pump to a screw. New technology offers an alternative design through a novel device called a

Surge Suppressor. The Surge Suppressor changes the traditional extruder dynamics in favor of a more uniform output without using a gear pump. We will briefly describe how the Surge Suppression Device works and report on preliminary results of testing.

Three patent applications have now been filed. This section of the paper will review the principles of operation of Surge Suppression and some of the data from Surge Suppressor tests.

Referring to the drawing below, the general layout of a Surge Suppressing Device is shown. The layout is shown for a typical horizontal extruder though in practice the Surge Suppressor is used on vertical discharge driven screws. All the tests were conducted on Randcastle's vertical extruders.

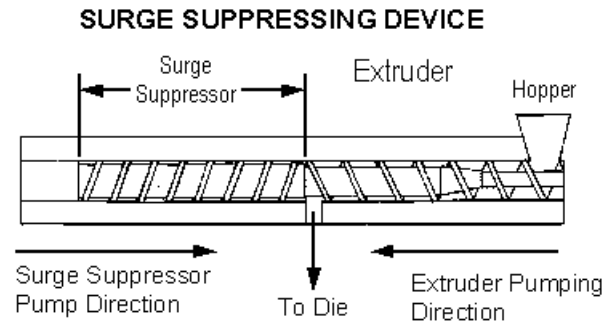

In, the extruder screw would pump polymer through the die and this would create pressure. The polymer pressure will then force material into the Surge Suppressor. But, because the pitch of the Surge Suppressor is opposite the main screw, pressure would start building in a direction opposite the metering section of the screw. The pressure will reach equilibrium pressure with the pressure in the metering section. This is similar in operation to a dynamic seal or a viscous seal.

Until recently, it was thought that a simple steady state condition would then develop. However, the situation is actually more complex. Let us think of a surge in terms of pressure. Let us further imagine that the wave is perfectly sinusoidal.

Referring to the drawing below, notice that the Surge Suppressor reaches an equilibrium pressure at a particular fill length. When higher pressure part of a surge upsets this equilibrium, it will take additional fill length to reach a new equilibrium pressure. So, instead of the entire surge coming out the die (as in a screw with Surge Suppression), that part of the surge is stored in the Surge Suppressor. Because the material does not leave the die, the pressure flow at the die is more uniform and the extrudate is more consistent.

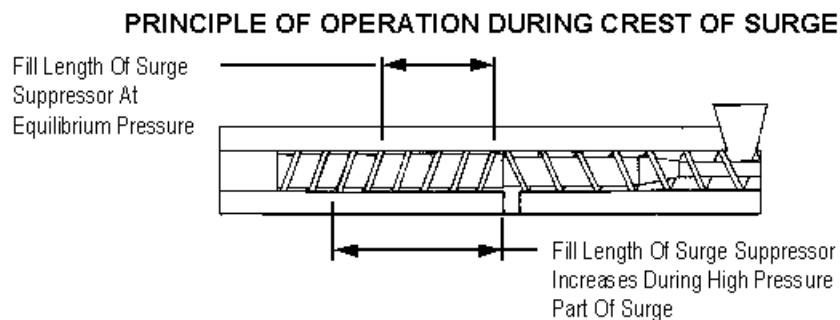

Referring to the drawing below, when the surge pressure reduces, the fill length in the Surge Suppressor will return to its original filled length or even empty further. Consequently, it will fill in the lower trough of the surge.

PRINCIPLE OF OPERATION DURING TROUGH OF SURGE

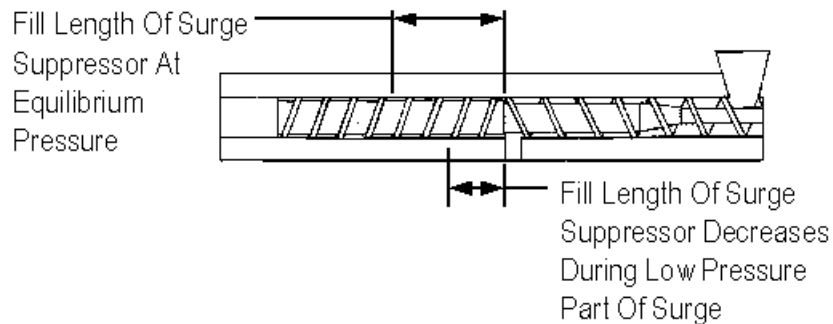

When the a complete wave is considered, the crest of the surge is removed and the trough of the surge is filled. Overall, a more stable pressure is occurs. A more uniform extrudate is therefore realized.

It is important to realize the speed with which the this surge suppression takes place and the magnitude of the suppression. This has important repercussions. To demonstrate the magnitude and speed of the Surge Suppressor, an “off-line” Surge Suppressor was built. This is shown schematically below:

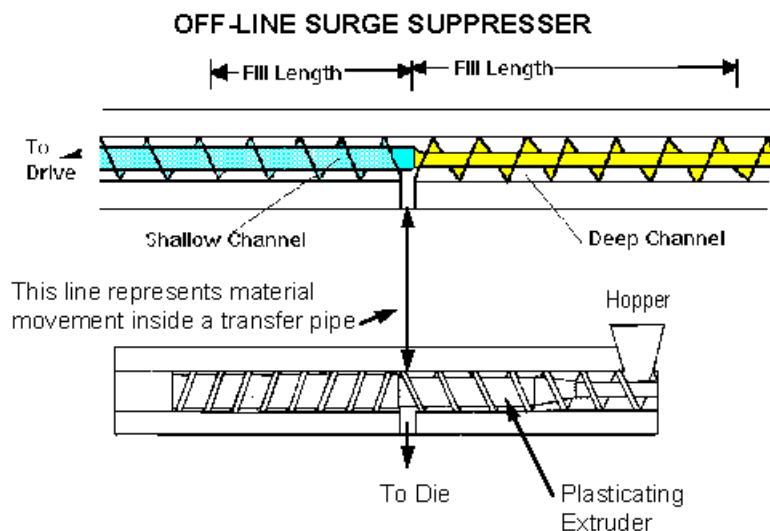

For the first part of this test, only the Plasticating Extruder was run with LDPE. The heaters on both “off-line” Surge Suppressor and the transfer pipe connecting the “off-line” Surge Suppressor and the Plasticating extruder were both turned off. Pressure was measured at the end of the metering section of the Plasticating Extruder barrel. Pressures were recorded so that very short term surging could be observed. Specifically, the short term surging known to exist as the screw flight passes the pressure sensor (Ref.12). This form of short term pressure fluctuation in pressure is known as, “Screw Beat.” Generally, this type of surging is ignored completely. It is thought to result from the higher pressure of the pushing side of the flight compared to the trailing side of the flight.

When the plasticating extruder was run (without the Surge Suppressor), screw beat was found to have a magnitude of about 25 pounds. See the graph below. Note that the short term screw beat surging is superimposed over longer term drift.

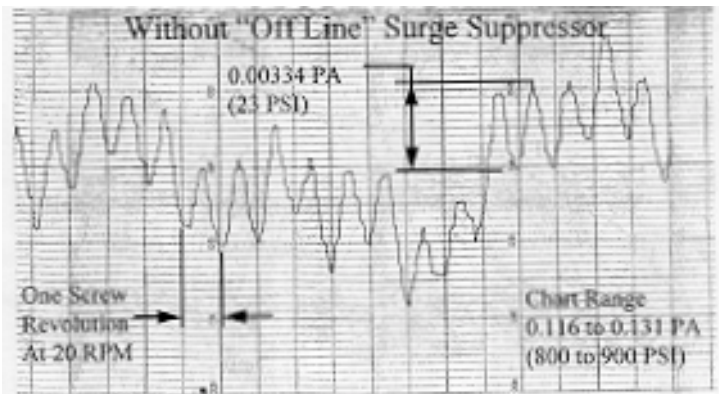

The Surge Suppressor was then heated so that polymer could move back and forth between the Surge Suppressor and the plasticating extruder. Screw beat was significantly reduced. Note the change in the shape of the Surging Waves.

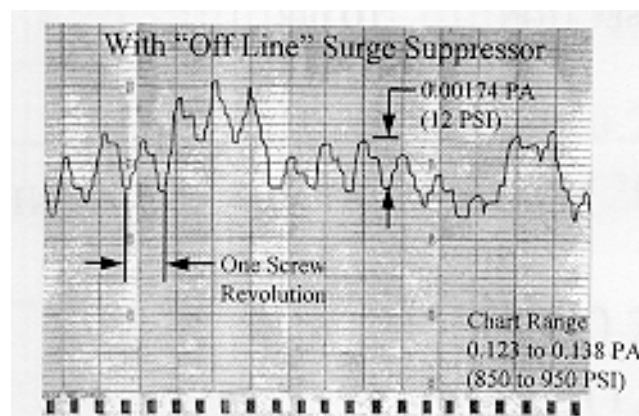

From this experiment, it seems clear that the Surge Suppressor can reduce short term surging in a fairly dramatic way given that the pressure sensor is very near the screw flight.

Still, the utility of the Surge Suppressor was called into question for two important reasons:

- 1) **SHORT TERM NATURE OF THE SUPPRESSION:** In the graphs above, and in general, short term surging is superimposed on long term surging. Long term surging tends to be much bigger than the short term surging. So, it has been assumed that short term surging can be ignored.
- 2) **POTENTIAL FOR DEGRADATION:** It is assumed that the polymer within the Surge Suppressor is not renewed. It is then assumed that the polymer within the Surge Suppressor is stagnant and under temperature and will therefore degrade. Such degradation then has the chance to contaminate the extrudate.

What has been discovered is rather surprising.

Rather complex strategies have been proposed to deal with long term surging. These include valves (Ref. 13), varying the screw speed and die resistance (Ref. 14.) and particularly complex screw designs (Ref. 15).

The most widely accepted system for improving the pressure stability of an extrusion line is a gear pump. Very precise gears, precisely rotated by a separate drive means, effectively dampen the fluctuations of the extruder. One study shows a 750 pound input pressure change at the suction side of the gear pump being reduced to 100 pounds at the output of the pump. So, this is roughly an eight fold improvement in pressure stability. This is roughly like saying that a 750 pound surge can be reduced by about 8 fold using a gear pump.

Gear pumps have nearly a fixed output at a specific speed. Extruders do not. The output tends to drift about a mean. Because of this, it is necessary that the input pressure (the suction side of the gear pump) be regulated. Otherwise, excessive pressure or too little pressure is likely to result. It is a standard practice for extruders with a gear pump to have a pressure controller for this purpose. Pressure is measured at the suction side of the pump, and the screw speed is slowly altered to correct for long term drift.

The question is: Why is it not common for such pressure controllers to be used on extruders, *without a gear pump*, to remove the same long term drift? Negative data is not commonly published. However, the author has made several attempts at controlling the screw speed with a standard pressure controller when no gear pump was placed on the extruder. The results were disappointing. Essentially, you started with a fairly stable pressure (say plus or minus 100 pounds of set point). You then turned on the pressure controller and the pressure got worse. Within a short time, the pressure was driven into completely random behavior resulting in pressure of about plus or minus 1,000 pounds. Many hours were spent trying to tune the controller to no avail. It seemed that the only way to have the controller do anything useful was to dampen its response so much that any operator could do much better in the normal course of his job.

The reason for this failure is, apparently, because the control signal was “off phase” with the requirement. That is, by the time that the sensor picked up a signal, transmitted it to the controller, the controller told the screw to do something, the screw drive had a chance to react, the torque was transmitted through the transmission and screw, the signal was not what it should have been. Essentially, you were likely to be telling the screw to speed up when you should have been telling it to slow down. This made the pressure worse and worse driving a reasonably stable pressure into an unstable one.

Yet, pressure controllers do work with gear pumps and do control long term drift.

An experiment was performed on standard Randcastle extruder (without a gear pump) equipped with a Surge Suppressor and an off the shelf pressure controller. Nylon 6 was processed in a screw known to be inadequate. Specifically, a general purpose 3:1 apparent compression ratio screw where the feed, transition, and metering section were evenly divided in length. Feed depth was 0.180 and meter 0.060 channel depth. A breaker plate, without screens, and a single strand fiber die with a 0.030 inch die diameter was used.

Nylon 6 is well known as a material that requires a higher compression ratio in the 4 to 4.5:1 range.

The results of the initial testing were as expected. That is, significant surging was seen and recorded. The variation in pressure was about 1,450 psi with an approximate average pressure of 4400 psi.

The results of the testing with the automatic screw speed control were somewhat unexpected. Merely by pushing the “automatic” button, the pressure became much more stable. As can be seen in the graph that follows, the pressure stabilized within about a 400 psi range.

Nylon Experiment

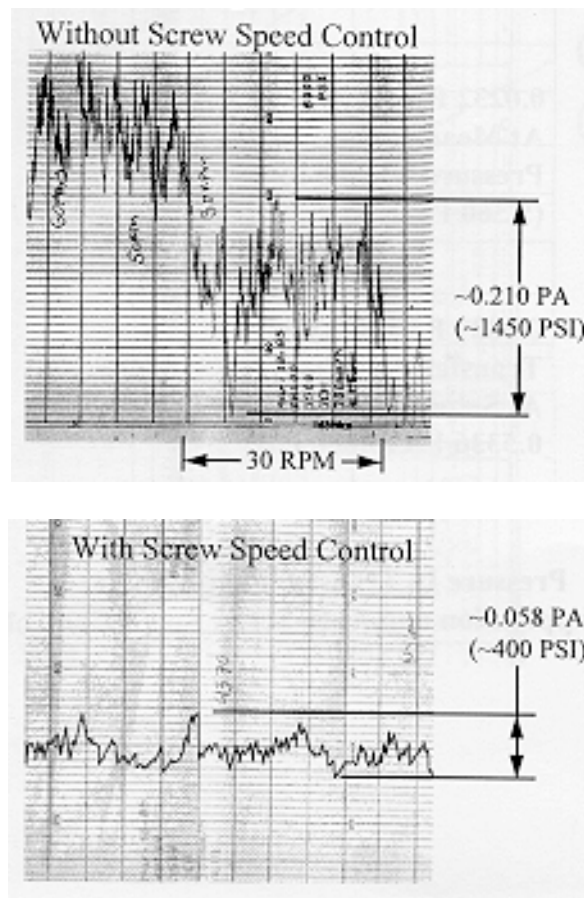

Another striking factor is that the pressure controller was not tuned greatly to achieve these results. We simply took general numbers for the rate, reset, and so on. These produced the graphed results easily. The other problem mentioned earlier was the stagnation thought to occur in the Surge Suppressor. This possible problem has also been addressed. At first, field selectable bleed ports over the Surge Suppressor were envisioned. The idea was to simply allow a small amount of leakage through the Surge Suppressor so that degraded material would not enter the die.

However, there is a better solution. It was found (Ref. 14) that Surge Suppressor channels with different dimensions might be tailored for different types of surges. It was then discovered that two parallel channels would have an unexpected property.

Specifically, shallow channels will pump efficiently. Deep channels being otherwise the same, will pump less efficiently. In the case of the Surge Suppressor, two parallel channels can be envisioned as shown in the drawing below. Because the channels have different depths, each channel will have different responses to surging. But, in addition, the shallow channel will have a short fill length and the deep channel will have a longer fill length. See the drawing below.

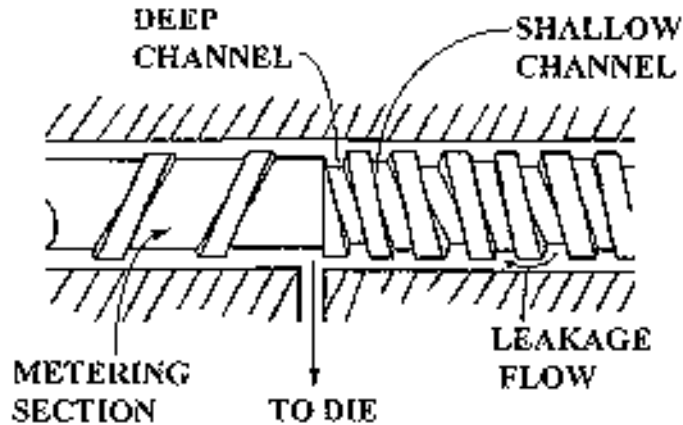

This would mean that part of the shallow channel will be empty but next to a filled deep channel. However, this case cannot exist indefinitely. There is a clearance between the flight that separates the two channels and the barrel of the Surge Suppressor. Consequently, there must be leakage between the filled deep channel and the shallow unfilled channel.

Once the shallow channel has more material in it than is necessary to reach the pressure in the extruder, the shallow channel will pump the material into the extruder and out the die. Thus, the Surge Suppressor has no stagnant material and is continuously renewed with material as it moves down the deep channel, over the intervening flight, into the shallow channel and out the die.

This principle of operation was tested in a simple way. A dual channel Surge Suppressor with one deep and one shallow channel was machined into a Randcastle 1/2 inch Microtruder. Yellow colored material was then processed for 30 minutes to ensure that the Surge Suppressor was filled with yellow material. Natural material then followed for a three hour period. The extruder screw was then removed. It had no yellow material in the Surge Suppressor.

This confirmed the general principle of operation. Subsequent experiments have shown that the residence time of the seal is twice that of the extruder without subsequent without additional modifications to enhance the feeding (such as by means of additional flight clearance or cuts in the flights (17, 18, 19).

Subsequent experiments in pressure stability of PVDF have shown that controlled barrel pressures of plus or minus 10 psi. (20)

ADDITIONAL SET UP CONSIDERATIONS

The HDPE, LLDPE, and PU trials were performed using a 0.076 rod die with a 5:1 land, and breaker plate without screens, and a Randcastle Model RCP-0625, 5/8 inch extruder with a 1 1/2 HP drive. The PU trials were conducted with limited amounts of material so it was not possible to do extensive tests. Long term drift is likely to be greater than the ~pressure recorded in the following charts.

All LDPE and flexible PVC trials were performed using a 0.060 monofilament die with a 10:1 land, a breaker plate with a 40, 80, 100 mesh screen pack and the same extruder.

MEAN PRESSURE: STANDARD FEED THROAT

HDPE	575	805	1375	1035	1120
LLDPE	960	1345	1595	1785	1960
LLDPE Modified	X	X	X	X	1260
LDPE	1760	2160	2535	2830	3115
FLEXIBLE PVC	1620	1755	1930	2045	2140
	20	40	60	80	100

RPM

MEAN PRESSURE: CLASSIC FEED THROAT

HDPE	1065	1365	1635	1830	1890
LLDPE	970	1330	1575	1735	1905
LLDPE Modified	X	X	X	X	1350
LDPE	2205	2415	3295	3595	3820
FLEXIBLE PVC	1460	1775	2010	2155	2240
	20	40	60	80	100

RPM

MEAN PRESSURE: AGGRESSIVE FEED THROAT

HDPE	1100	1435	1640	1825	1950
LLDPE	980	1380	1635	1850	1995
LLDPE Modified	925	1355	1585	1810	2010
LDPE	2000	2375	2600	2850	3085
FLEXIBLE PVC	1685	2150	2370	2560	2775
	20	40	60	80	100

RPM

TECOTHANE 55 D STANDARD FEED SECTION

Run	Gr./min.	RPM	Zn.1	Zn. 2	Zn.. 3	Die	Melt	Pressure	Amps
1	15.2	20	400	420	430	430	431	71 to 82	3
2	25.4	40	415	420	420	400	431	170 to 180	2
3	35.6	60	415	420	420	400	440	240 to 260	4
4	37.2	80	415	420	420	400	440	330 to 350	5
5	42.4	100	415	420	420	400	440	480 to 490	5

**TECOTHANE 55 D
CLASSIC FEED SECTION**

Run	Gr./min.	RPM	ZN.1	Zn. 2	Zn.. 3	Die	Melt	~Pressure	Amps
1	17.2	20	415	420	420	400	435	80 to 90	3
2	26.0	40	415	420	420	400	434	240 to 255	5
3	39.0	60	415	420	420	400	433	420 to 435	7
4	53.2	80	415	420	420	400	434	630 to 650	7.5
5	64.0	100	415	420	420	400	437	710 to 780	8

**TECOTHANE 55 D
AGGRESSIVE FEED SECTION**

Run	Gr./min.	RPM	ZN.1	Zn. 2	Zn.. 3	Die	Melt	~Pressure	Amps
1	18.4	20	415	420	420	400	435	90 to 100	4.5
2	32.4	40	415	420	420	400	433	260 to 300	7.2

**TECOTHANE 75 D
STANDARD FEED SECTION**

Run	Gr./min.	RPM	ZN.1	Zn. 2	Zn.. 3	Die	Melt	~Pressure	Amps
1	17.4	20	415	420	425	400	438	155 to 165	3
2	29.4	40	415	420	425	400	441	330 to 345	4.8
3	38.6	60	415	420	425	400	440	350 to 375	5.4
4	52.2	80	415	420	425	400	440	500 to 540	6.2
5	62.8	100	415	420	425	400	441	575 to 625	4.8

**TECOTHANE 75 D
CLASSIC FEED SECTION**

Run	Gr./min.	RPM	ZN.1	Zn. 2	Zn.. 3	Die	Melt	~Pressure	Amps
1	17.0	20	415	420	425	400	436	160 to 200	3
2	30.2	40	415	420	425	400	438	400 to 500	5
3	42.6	60	415	420	425	400	438	740 to 760	6
4	53.0	80	415	420	425	400	439	940 to 960	6.6
5	63.4	100	415	420	425	400	441	1030 to 1060	7

**TECOTHANE 75 D
AGGRESSIVE FEED SECTION**

Run	Gr./min.	RPM	ZN.1	Zn. 2	Zn.. 3	Die	Melt	~Pressure	Amps
1	18.8	20	415	420	425	400	437	85 to 95	3.8
2	32.2	40	415	420	425	400	438	205 to 215	5.8
3	42.2	60	415	420	425	400	438	330 to 375	7.2
4	56.4	80	415	420	425	400	438	625 to 660	7.6
5	-	100	415	420	425	400	439	-	Over 8

**PELLATHANE 55 D
STANDARD FEED SECTION**

Run	Gr./min.	RPM	ZN.1	Zn. 2	Zn.. 3	Die	Melt	~Pressure	Amps
1	11.8	20	400	410	415	400	427	70 to 80	1.8- 2.4
2	20.6	40	400	410	415	400	430	90 to 100	3.4-4.0
3	30.2	60	400	410	415	400	437	130 to 175	3.8-4.6
4	40.8	80	400	410	415	400	439	300 to 340	5.0-5.6
5	50	100	400	410	415	400	439	625 to 650	6.0-6.6

**PELLATHANE 55 D
CLASSIC FEED SECTION**

Run	Gr./min.	RPM	ZN.1	Zn. 2	Zn.. 3	Die	Melt	~Pressure	Amps
1	13.4	20	400	410	415	400	428	95 to 105	3.4
2	26.6	40	400	410	415	400	429	250 to 300	5.8
3	38.2	60	400	410	415	400	429	415 to 470	6.2-7.0
4	50.0	80	400	410	415	400	430	650 to 700	7.2-7.8
5	60.0	100	400	410	415	400	432	Not Taken	>8

**PELLATHANE 55 D
AGGRESSIVE FEED SECTION**

Run	Gr./min.	RPM	ZN.1	Zn. 2	Zn.. 3	Die	Melt	~Pressure	Amps
1	8.2	20	400	410	415	400	428	240 to 250	2.0-2.6
2	18.4	40	400	410	415	400	414	750 to 800	4.2-5.0
3	30.6	60	400	410	415	400	418	1200 to 1250	4.6-5.0
4	42.4	80	400	410	415	400	425	1400 to 1550	5.8-6.0
5	50.2	100	400	410	415	400	432	1600 to 1680	5.6-7.4

**PELLATHANE 75 D
STANDARD FEED SECTION**

Run	Gr./min.	RPM	ZN.1	Zn. 2	Zn.. 3	Die	Melt	~Pressure	Amps
1	17.2	20	410	420	425	410	424	500 to 650	4.0-4.6
2	28.0	40	410	420	425	410	426	840 to 885	6.2-6.6
3	38.6	60	410	420	425	410	425	890 to 950	7.0-8.0
4	48.2	80	410	420	425	410	442		7.6-8.0
5	61.6	100	410	420	425	410	443		7.2

**PELLATHANE 75 D
CLASSIC FEED SECTION**

Run	Gr./min.	RPM	ZN.1	Zn. 2	Zn.. 3	Die	Melt	~Pressure	Amps
1	14.6	20	410	420	425	410	438	380 to 410	3.0-4.0
2	27.4	40	410	420	425	410	438	440 to 580	6.0
3	40.2	60	410	420	425	410	438	820 to 865	7.2-7.4
4	52.2	80	410	420	425	410	439	1180 to 1230	7.8-8.0

5	65.2	100	410	420	425	410	441	1260 to 1320	8.2-8.4
---	------	-----	-----	-----	-----	-----	-----	--------------	---------

**PELLATHANE 75 D
AGGRESSIVE FEED SECTION**

Run	Gr./min.	RPM	ZN.1	Zn. 2	Zn.. 3	Die	Melt	~Pressure	Amps
1	16.4	20	410	420	425	410	434	395 to 410	4.3
2	32.2	40	410	420	425	410	437	545-	8

References

- (1) Chris Rauwendaal, *Polymer Extrusion*, Hanser Publishers, 1988, page 65-66.
- (2) Tadmor and Klein, *Engineering Principles of Plasticating Extrusion*, Krieger Publishing Co., page 8.
- (3) *Polymer Processing Machinery*, The Plastics and Rubber Institute, Second International Conference, July 9, 1987, page 3/10.
- (4) Allan L. Griff, *Plastic Extrusion Technology*, Kreiger Publishing, page 3.
- (5) *Plastic Extrusion Technology*, Friedhelm Hensen, Editor, 1988, pages 101, 226, 374, and 381.
- (6) *Ibid.*, page 684.
- (7) Windmoller & Hoelscher, Lincoln, RI, Andrew Wheeler, Private conversation with author.
- (8) Reifenhauer, Peabody, MA, Matthew D. Bangert, "Grooved Feed Extrusion Presentation, "SME Blown Film Clinic, October 18-19, 1993.
- (9) Filmaster, Fairfield, NJ, Frank Goffreda, "The Application of Groove Feed Extruders to Produce Mono-Layer and Coextruded Medical Films," Antec 1990, page 1121-1122.
- (10) *Ibid.*, Ref. (1) page 10.
- (11) *Ibid.*, Ref. (5), pages 683-684.
- (12) *Ibid.*, Ref. (2) page 412-413.
- (13) Patterson et al, "The Dynamic Behavior of Extruders," SPE ANTEC, p. 483-487 (1978)
- (14) Parnaby et al, "Development of Computer Control Strategies for Plastic Extruders," Polym. Eng. Sci., Volume 15, No. 8, p. 594-605 (1975).
- (15) Lee, US Patent No. 4,118,163.
- (16) Rauwendaal, "Analysis of Dynamic Seals In Screw Extruders," SPE ANTEC 1996.
- (17) US Randcastle Patent 5,486,328
- (18) US Randcastle Patent 5,518,672
- (19) US Randcastle Patent 5,569,429
- (20) Luker, "Surge Suppression—A New Means To Limit Surging," SPE ANTEC 1996 p.445-451.